

General Description

Series RV direct acting, pressure relief valves are designed to limit pressure in various parts of a hydraulic circuit. The relief valve function options are P to T, A to T, B to T or A & B to T. Another option is for A to B & B to A crossover relief functions.

Features

- High flow capacity.
- Pressure function in P, A, B or A + B.
- Sizes:
 - RV05 – NFPA D05 / NG10 / CETOP 5
 - RV5H – NFPA D05HE / NG10 / CETOP 5H
 - RV07 – NFPA D07 / NG16 / CETOP 7
 - RV08 – NFPA D08 / NG25 / CETOP 8

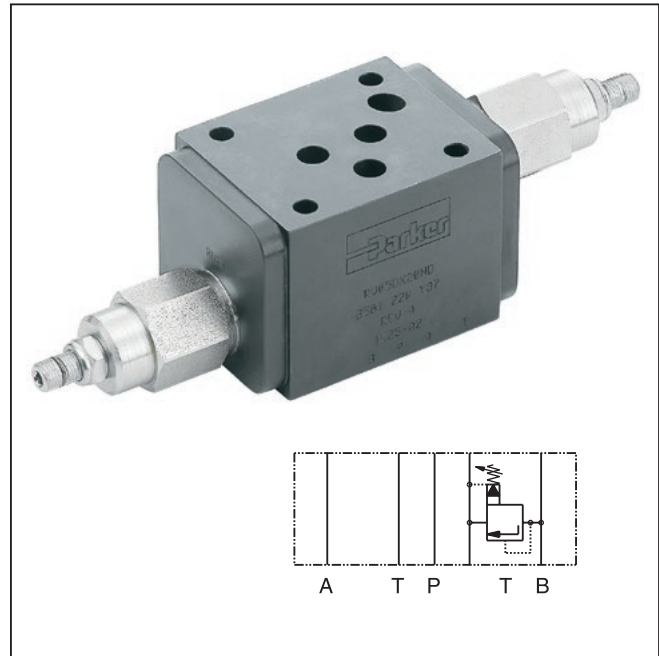

Specifications

General				
Size	D05 / NG10	D05HE / NG10	D07 / NG16	D08 / NG25
Mounting Position	Unrestricted			
Ambient Temperature Range	-20°C to +50°C (-4°F to +122°F)			
Hydraulic				
Maximum Operating Pressure	Aluminum Body – up to 207 Bar (3000 PSI); Ductile Iron Body – up to 345 Bar (5000 PSI)			
Nominal Flow	189 LPM (50 GPM)	189 LPM (50 GPM)	189 LPM (50 GPM)	378 LPM (100 GPM)
Leakage	10 DPM	10 DPM	10 DPM	10 DPM
Reseat Pressure	> 90% Setting			
Adjustment Screw Hex Size	5/32	5/32	5/32	5/32
Fluid Temperature	-20°C to +80°C (-4°F to +176°F)			
Viscosity	Permitted 10 to 650 cSt / mm ² /s (46 to 3013 SSU) Recommended 30 cSt / mm ² /s (139 SSU)			
Filtration	ISO Class 4406 (1999) 18/16/13 (acc. NAS 1638: 7)			

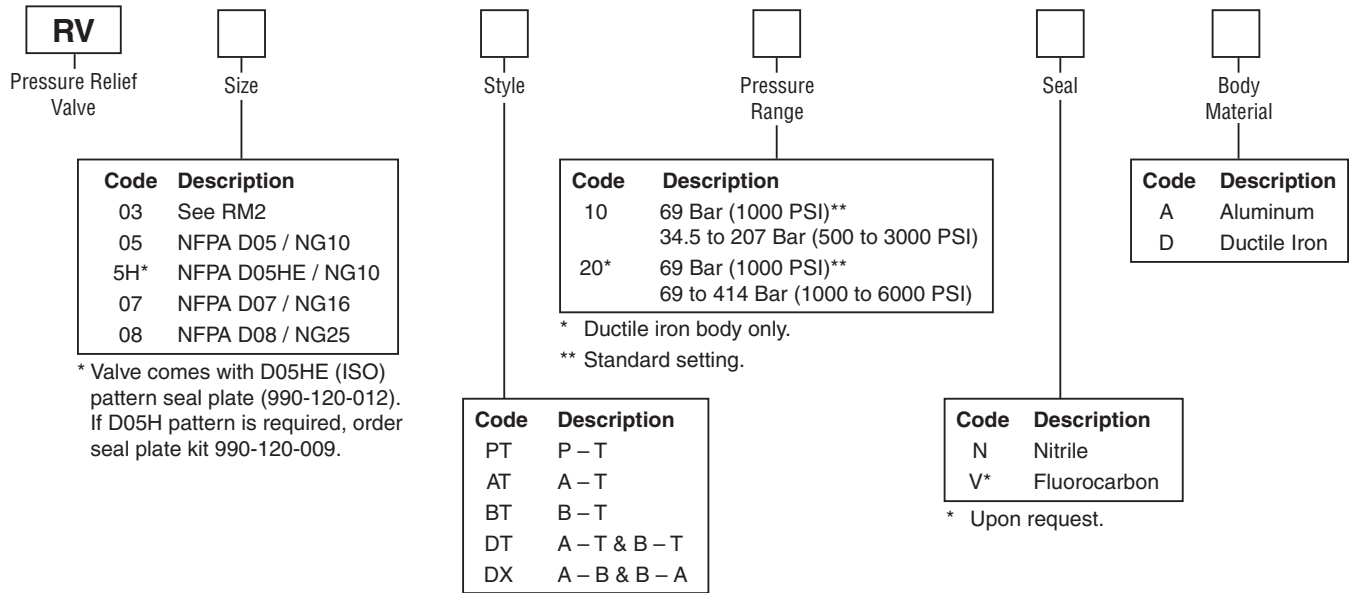

RVPT**

Pressure control P-T

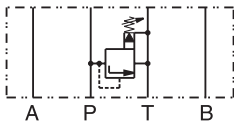

RVAT**

Pressure control A-T

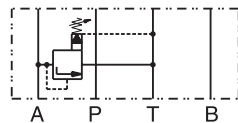

RVBT**

Pressure control B-T

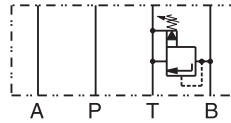

RVDT**

Pressure control A-T & B-T

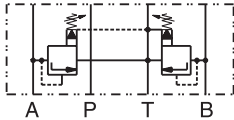

RVDX**

Pressure control A-B & B-A

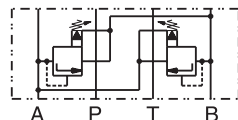

Weight:

Size	RV**AT30NA	RV**AT30ND	RV**BT30NA	RV**BT30ND	RV**DT30NA	RV**DT30ND	RV**DX30NA	RV**DX30ND	RV**PT30NA	RV**PT30ND
RV05, RV5H	1.0 kg (2.2 lbs.)	2.2 kg (4.8 lbs.)	1.0 kg (2.2 lbs.)	2.2 kg (4.8 lbs.)	1.2 kg (2.6 lbs.)	2.1 kg (4.7 lbs.)	1.4 kg (3 lbs.)	2.6 kg (5.7 lbs.)	1.0 kg (2.2 lbs.)	2.2 kg (4.8 lbs.)
RV07	1.7 kg (3.7 lbs.)	3.6 kg (7.9 lbs.)	1.5 kg (3.3 lbs.)	3.2 kg (7.2 lbs.)	2.6 kg (5.7 lbs.)	5.6 kg (12.3 lbs.)	2.1 kg (4.7 lbs.)	4.5 kg (10.0 lbs.)	1.5 kg (3.3 lbs.)	3.3 kg (7.2 lbs.)
RV08	3.9 kg (8.6 lbs.)	9.1 kg (20 lbs.)	3.8 kg (8.5 lbs.)	9 kg (19.7 lbs.)	5.6 kg (12.3 lbs.)	12.4 kg (27.4 lbs.)	4.4 kg (9.6 lbs.)	9.2 kg (20.3 lbs.)	3.9 kg (8.6 lbs.)	9.1 kg (20 lbs.)

RV05*10*A, RV5H*10*A, RV07*10*A

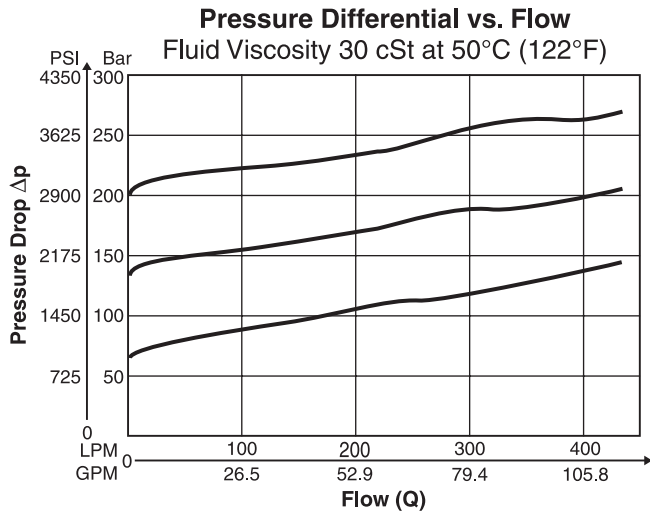

RV05*20*D, RV5H*20*D, RV07*20*D

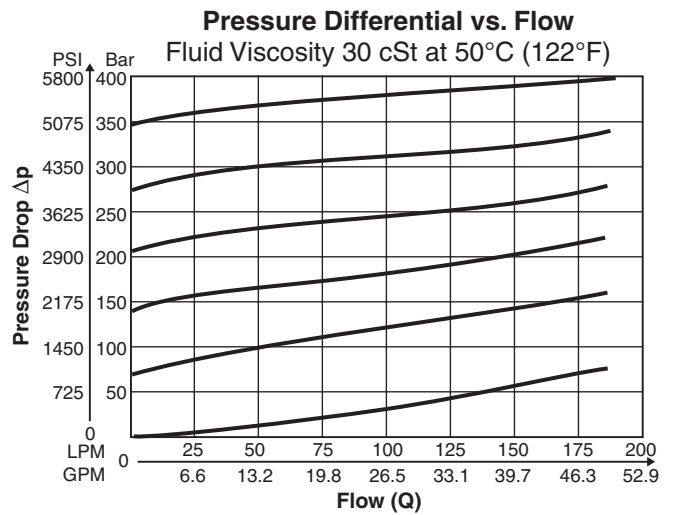

RV08*10*A

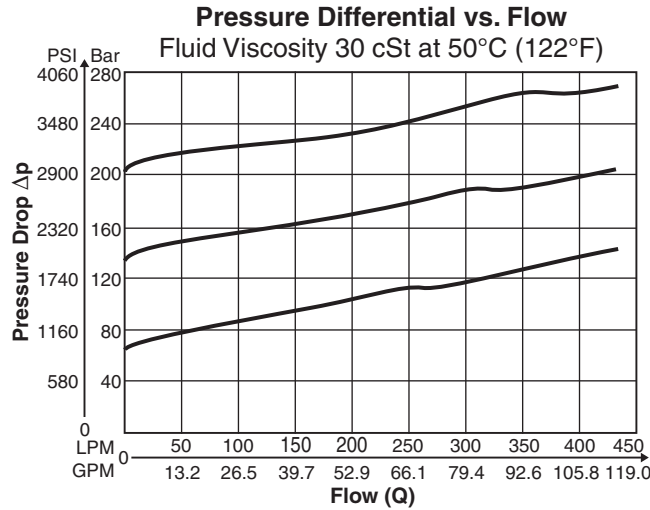

RV08*20*D

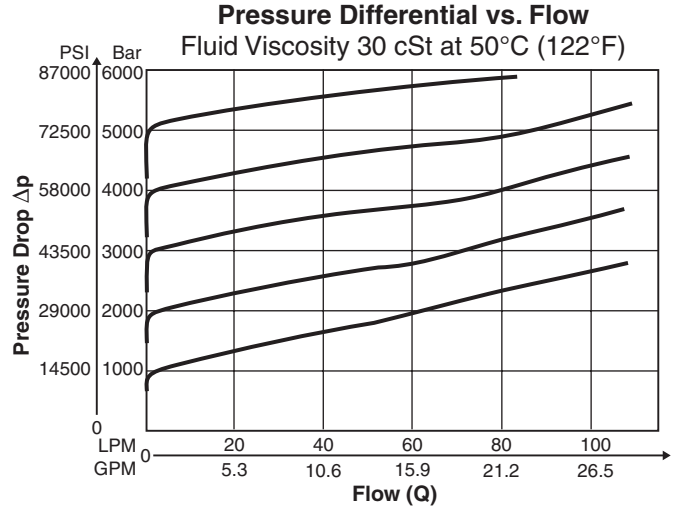

RV05AT — Inch equivalents for millimeter dimensions are shown in (**)

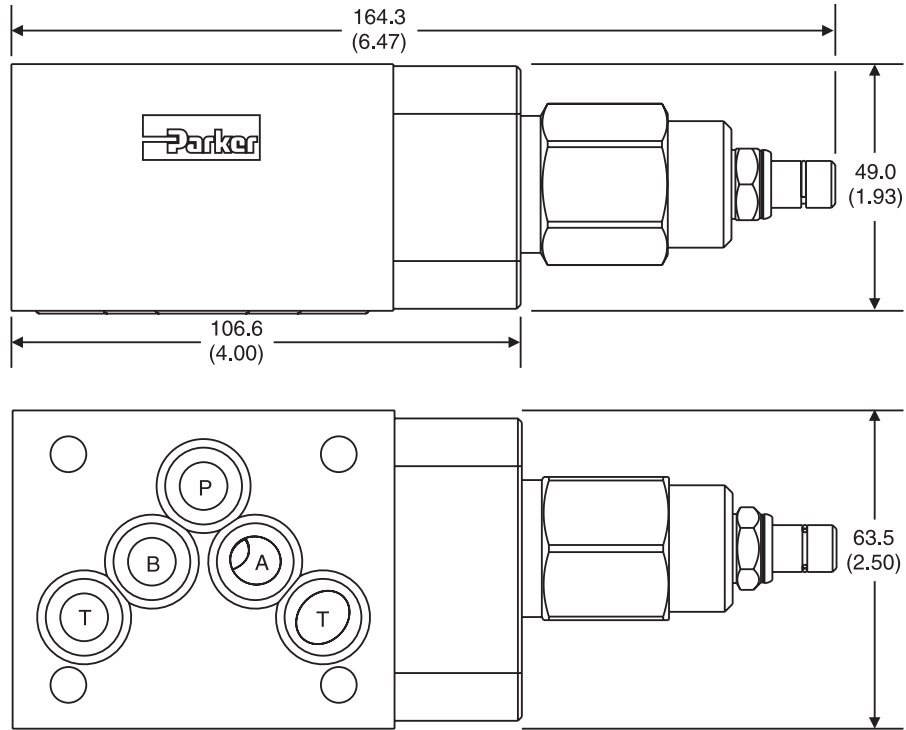

RV05BT — Inch equivalents for millimeter dimensions are shown in (**)

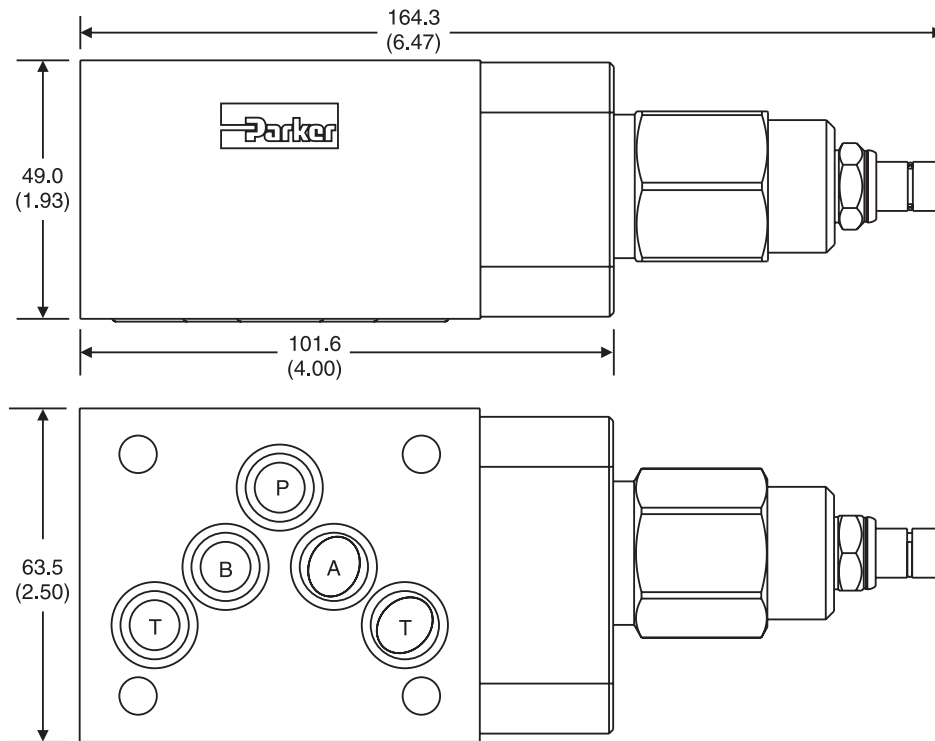

RV05DT – Inch equivalents for millimeter dimensions are shown in (**)

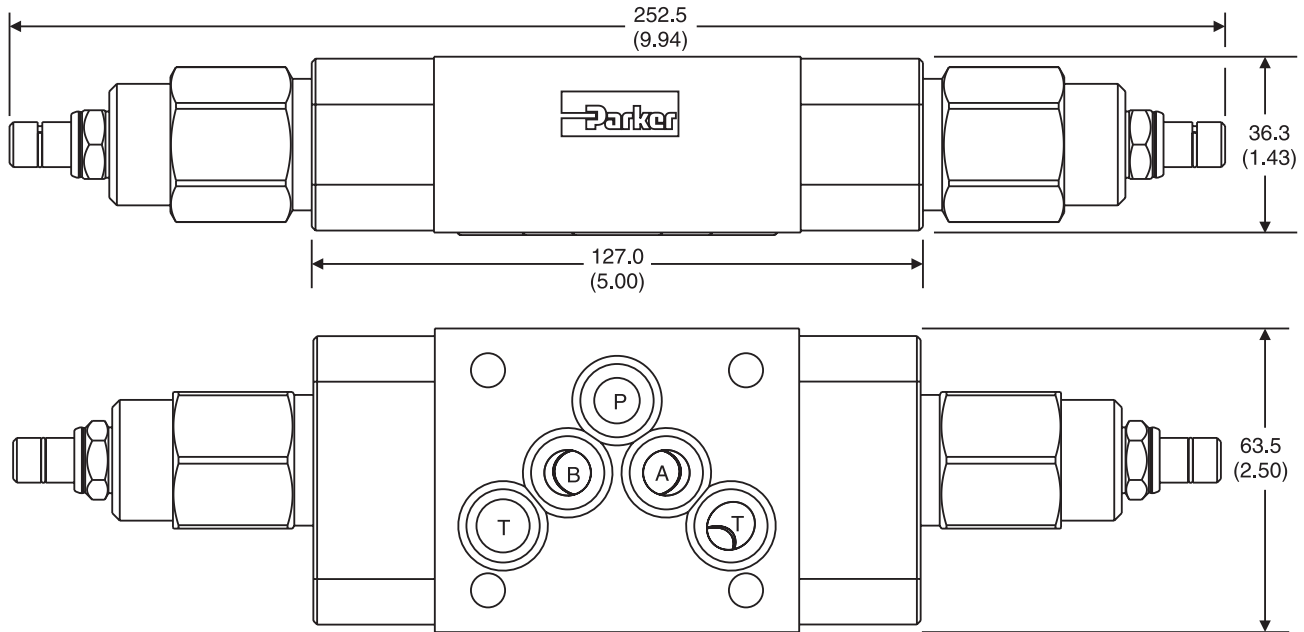

RV05DX – Inch equivalents for millimeter dimensions are shown in (**)

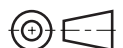
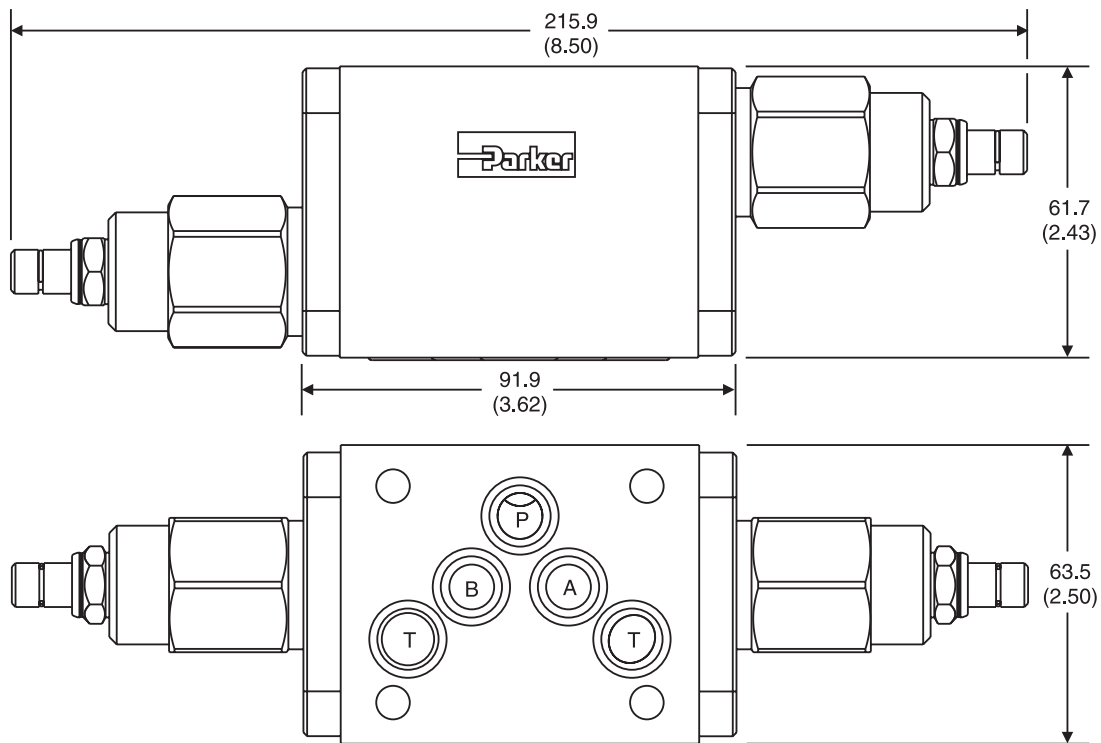

Dimensions

RV05PT – Inch equivalents for millimeter dimensions are shown in (**)

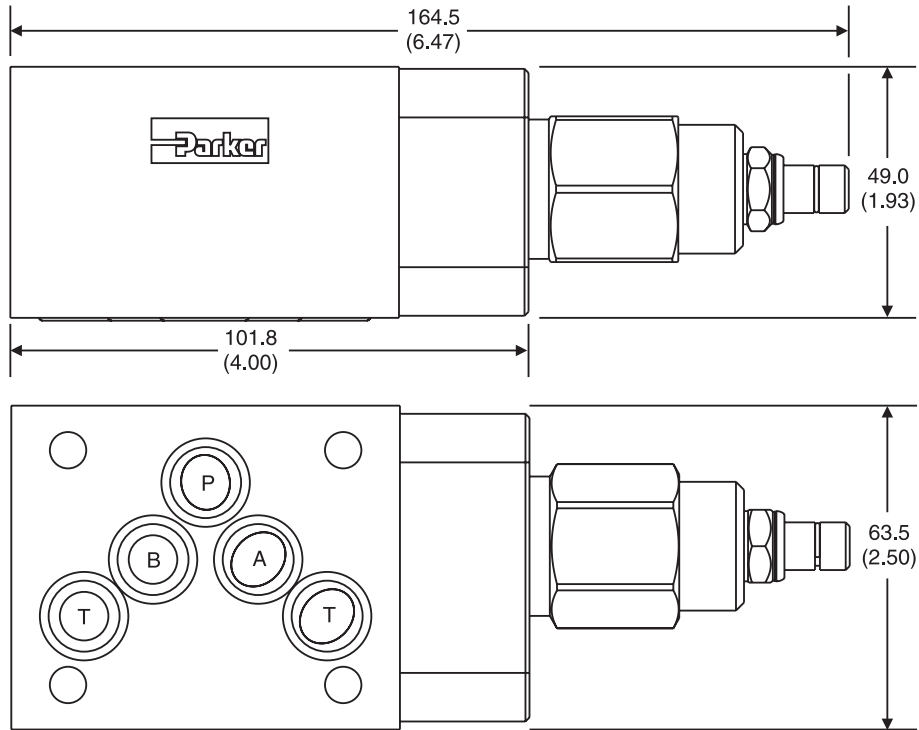

RV5HAT – Inch equivalents for millimeter dimensions are shown in (**)

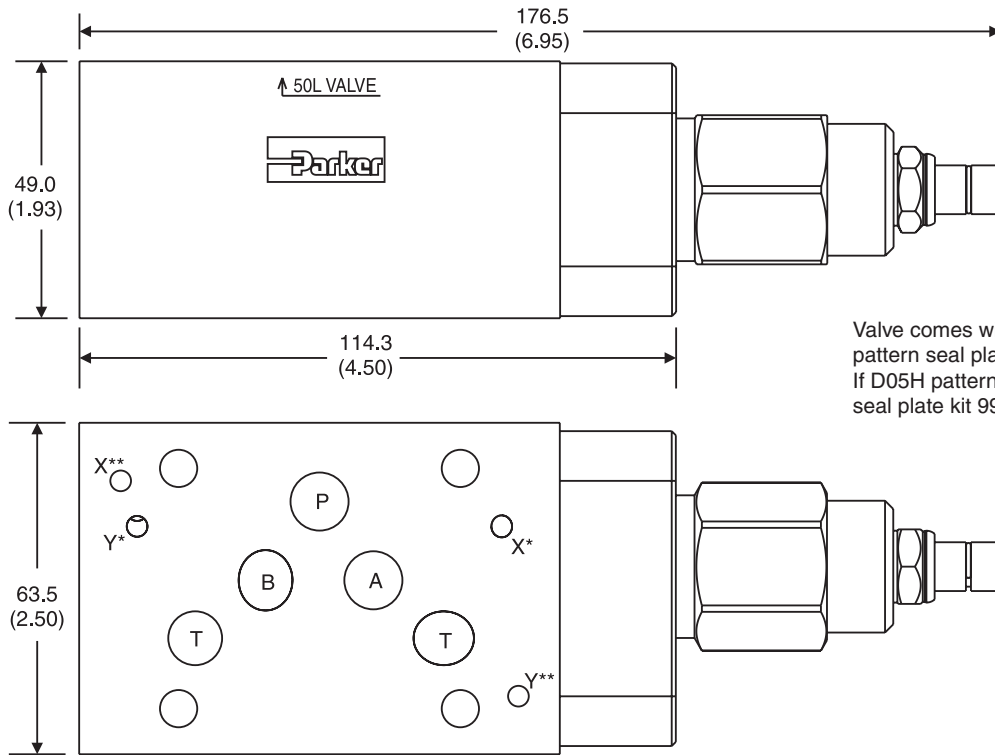

Valve comes with D05HE (ISO) pattern seal plate (990-120-012). If D05H pattern is required, order seal plate kit 990-120-009.

- * D05HE (Standard)
- ** D05H



Dimensions

RV5HBT – Inch equivalents for millimeter dimensions are shown in (**)

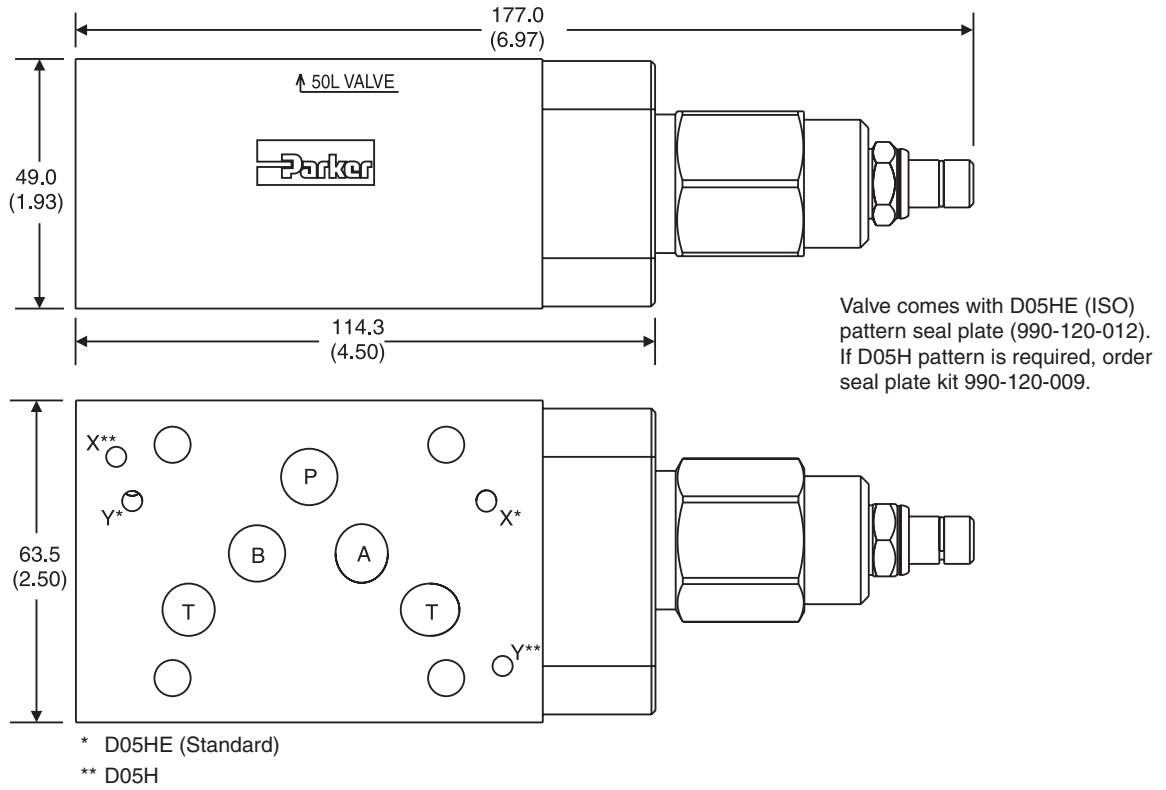

RV5HDT – Inch equivalents for millimeter dimensions are shown in (**)

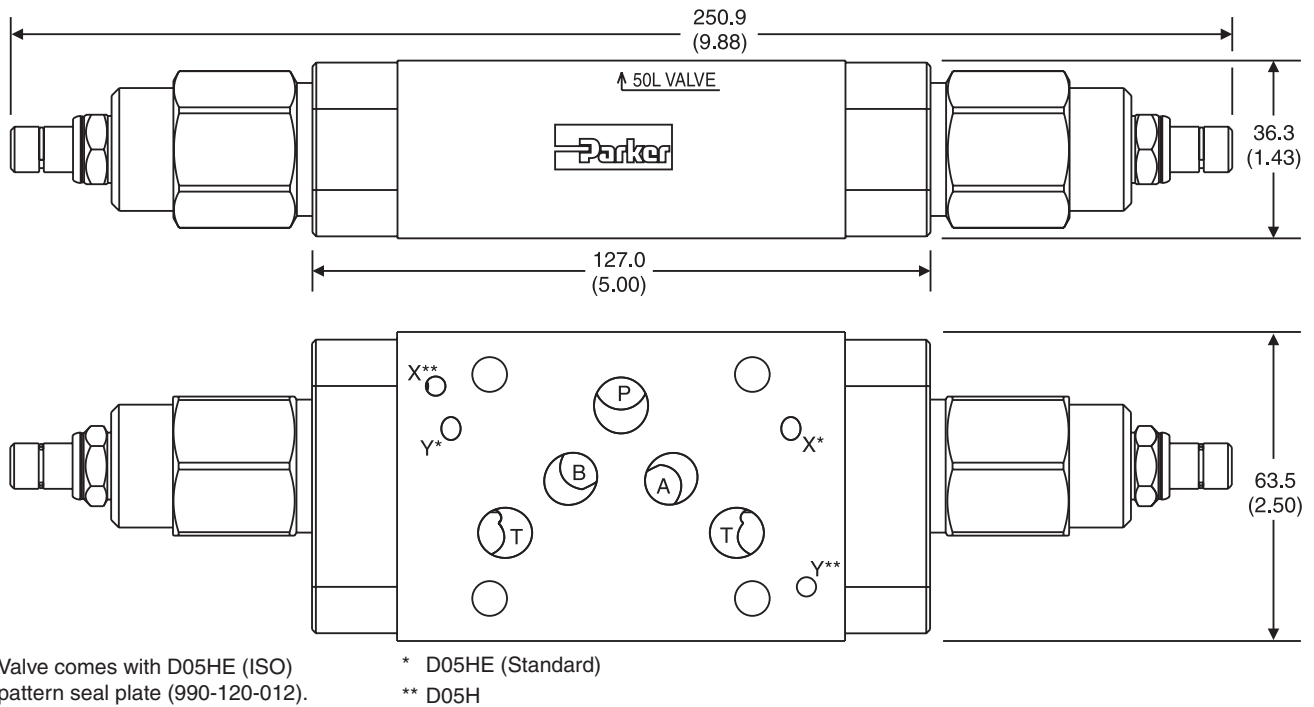

Dimensions

RV5HDX – Inch equivalents for millimeter dimensions are shown in (**)

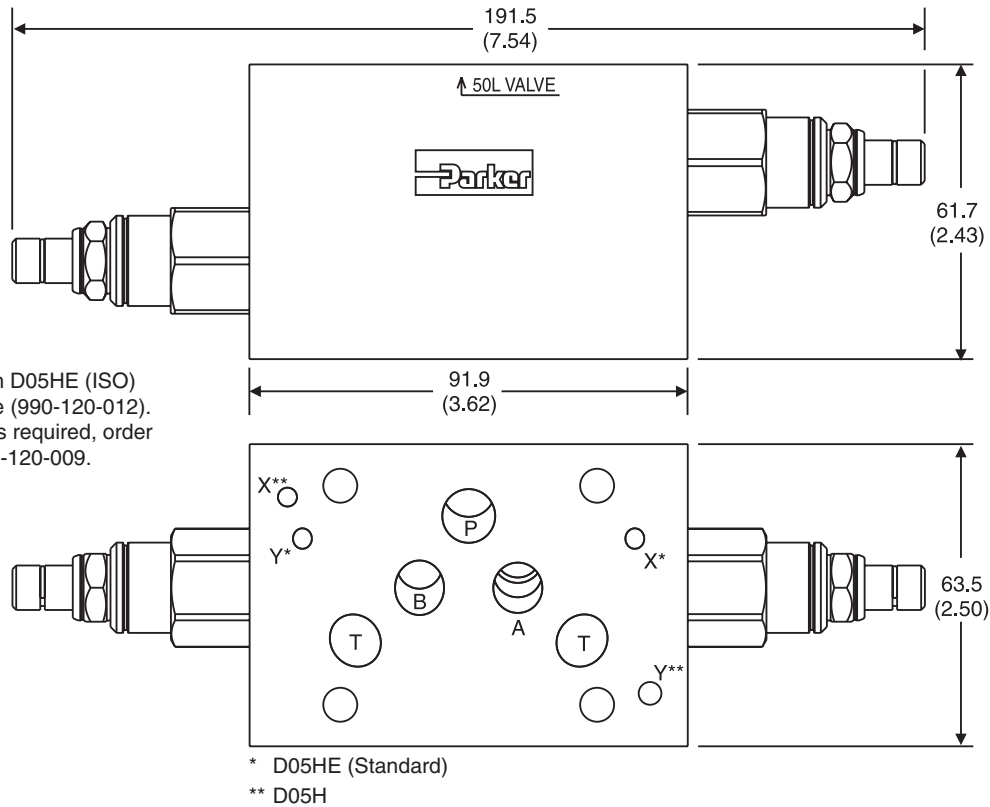

RV5HPT – Inch equivalents for millimeter dimensions are shown in (**)

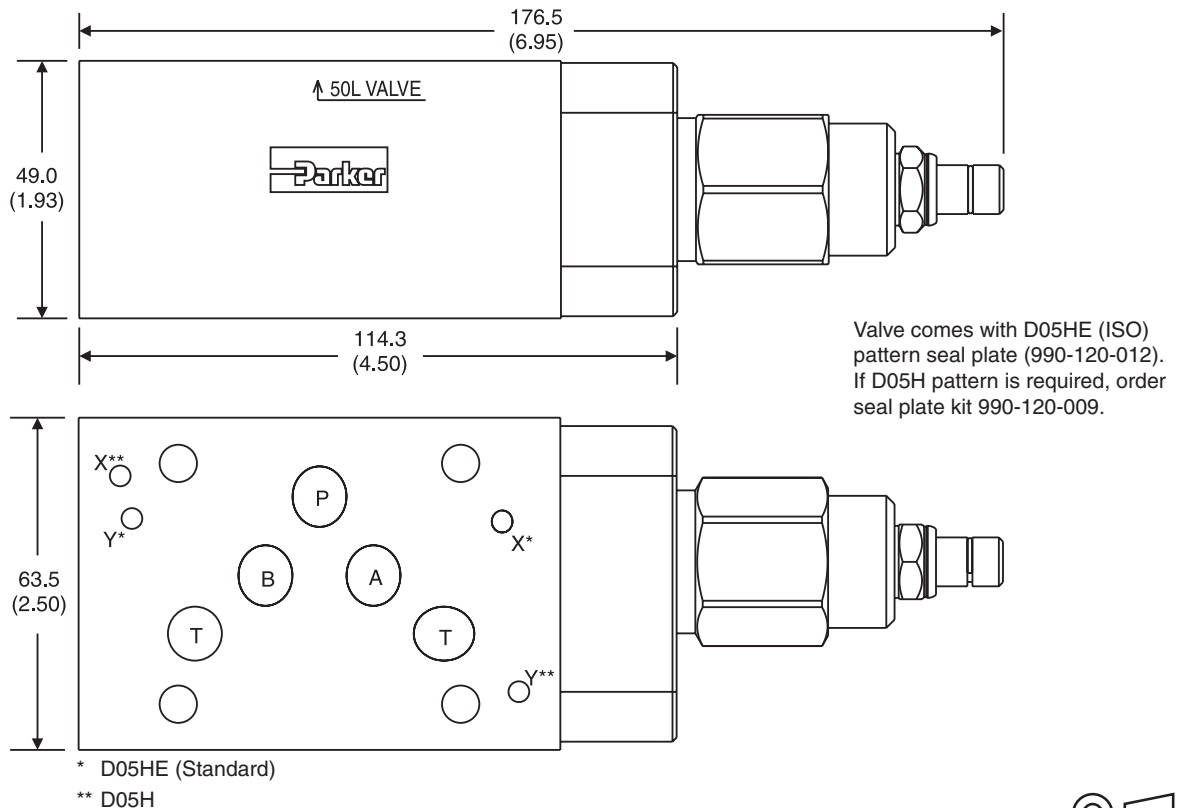

RV07AT – Inch equivalents for millimeter dimensions are shown in (**)

Note: This is a top view.

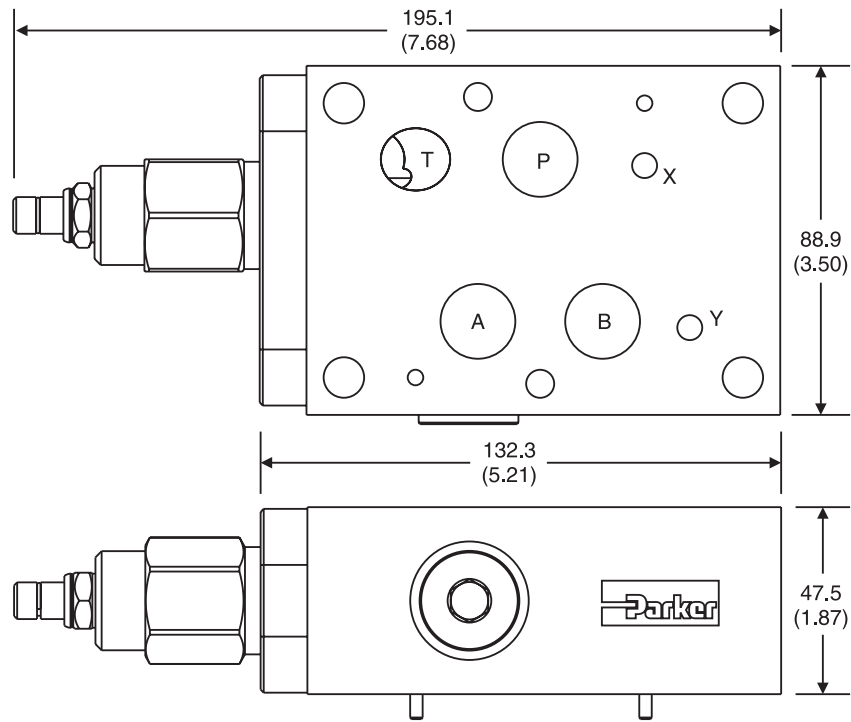

RV07BT – Inch equivalents for millimeter dimensions are shown in (**)

Note: This is a top view.

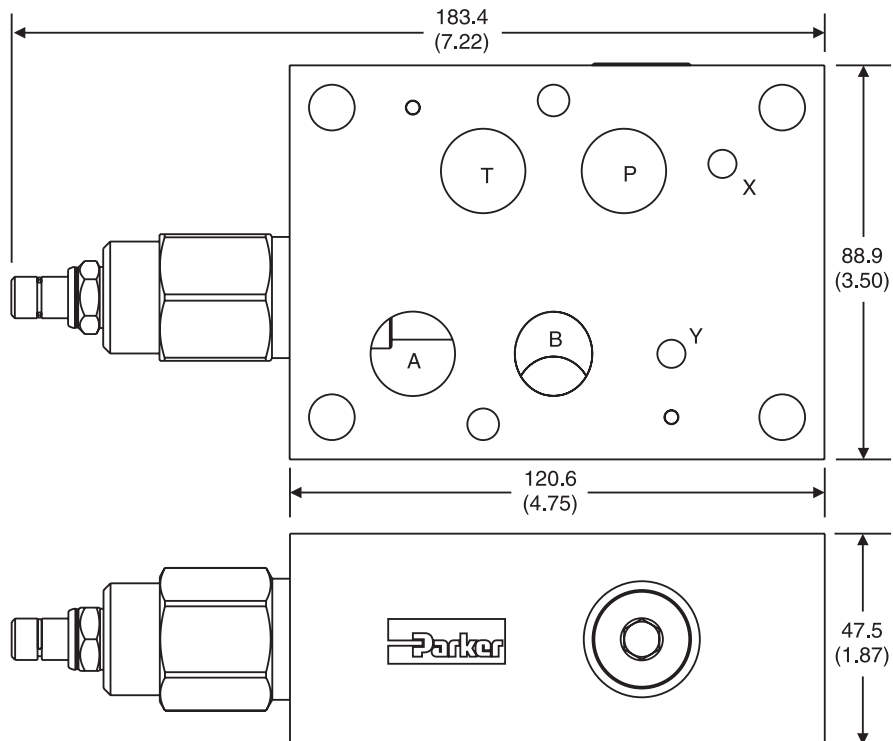

RV07DT – Inch equivalents for millimeter dimensions are shown in (**)

Note: This is a top view.

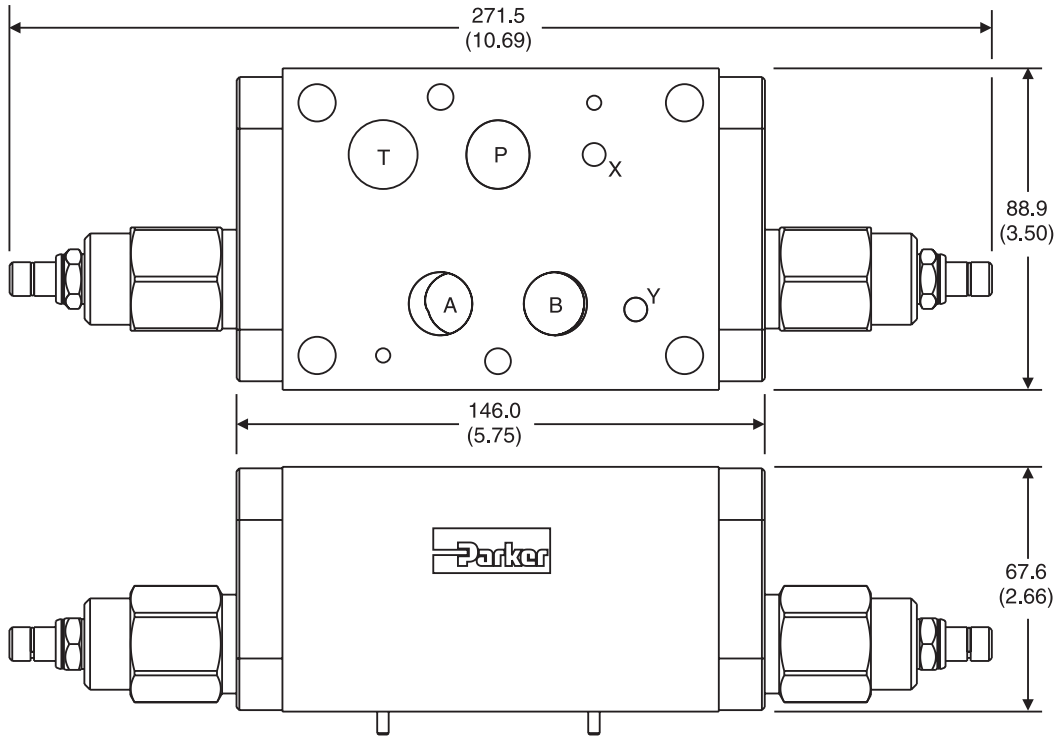

RV07DX – Inch equivalents for millimeter dimensions are shown in (**)

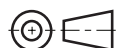
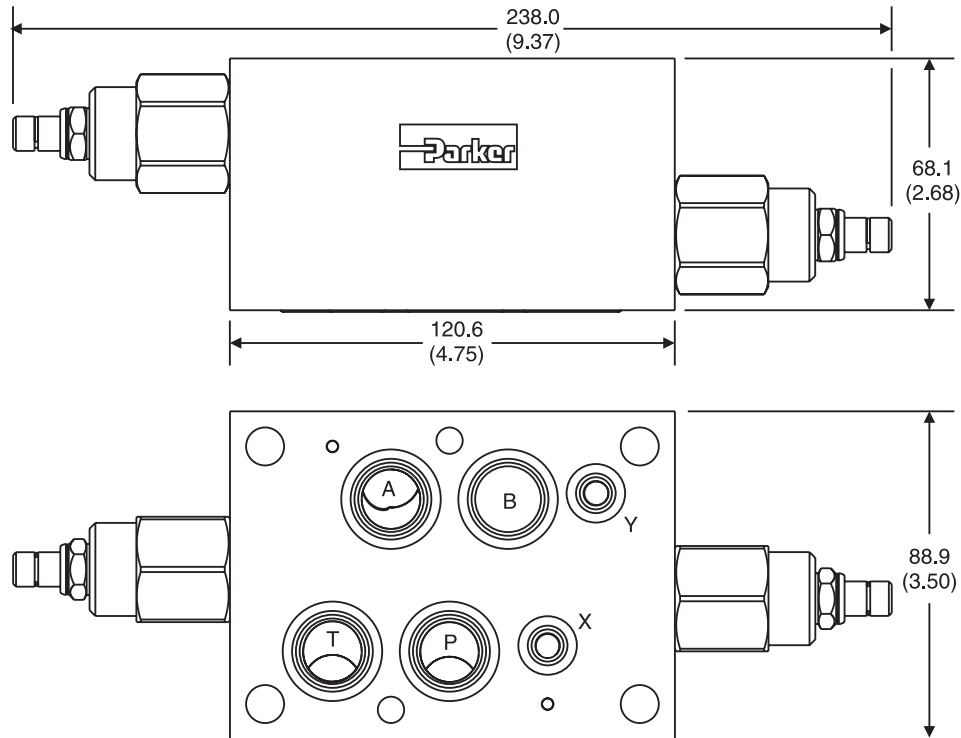

RV07PT – Inch equivalents for millimeter dimensions are shown in (**)

Note: This is a top view.

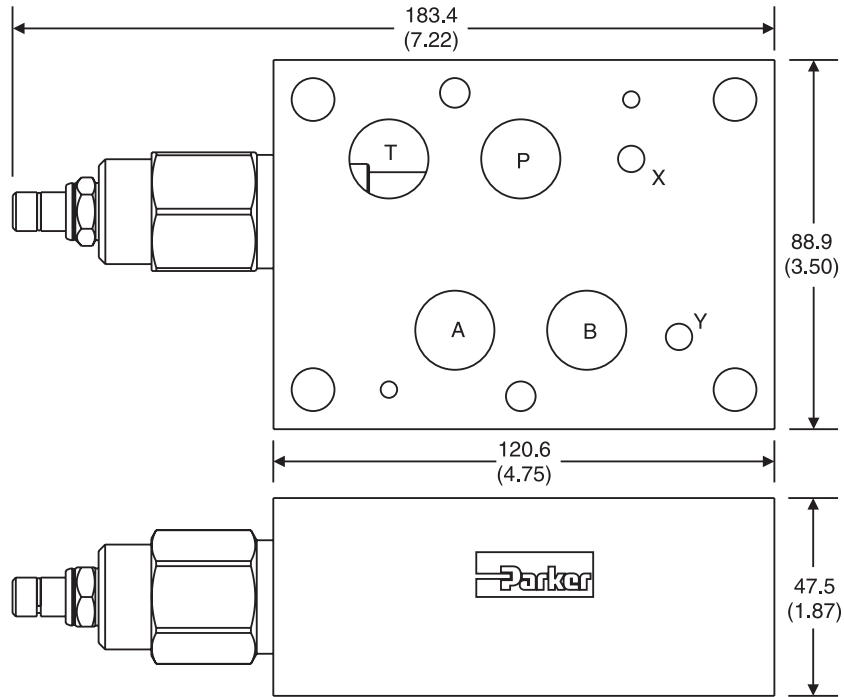

RV08AT – Inch equivalents for millimeter dimensions are shown in (**)

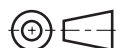
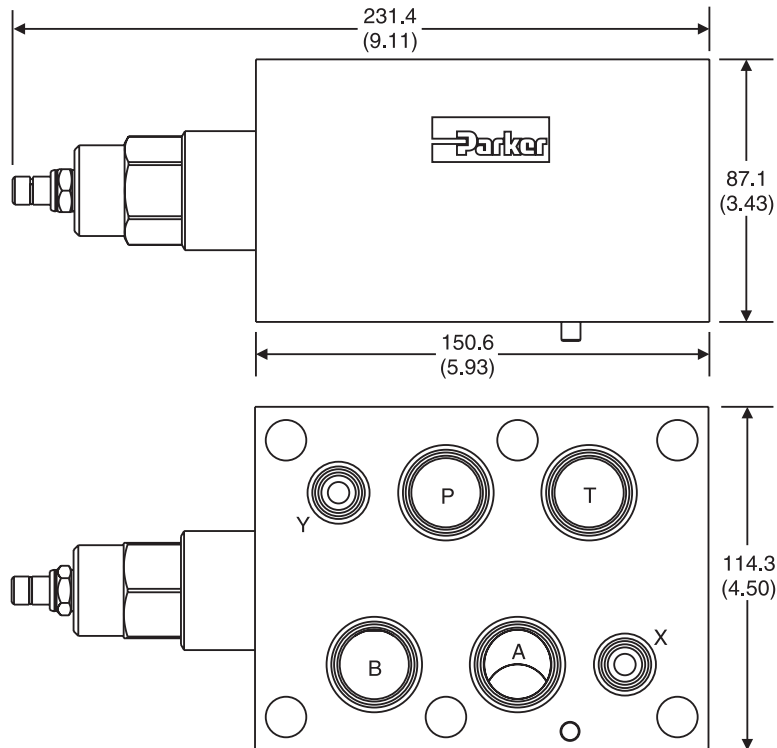

Dimensions

RV08BT — Inch equivalents for millimeter dimensions are shown in (**)

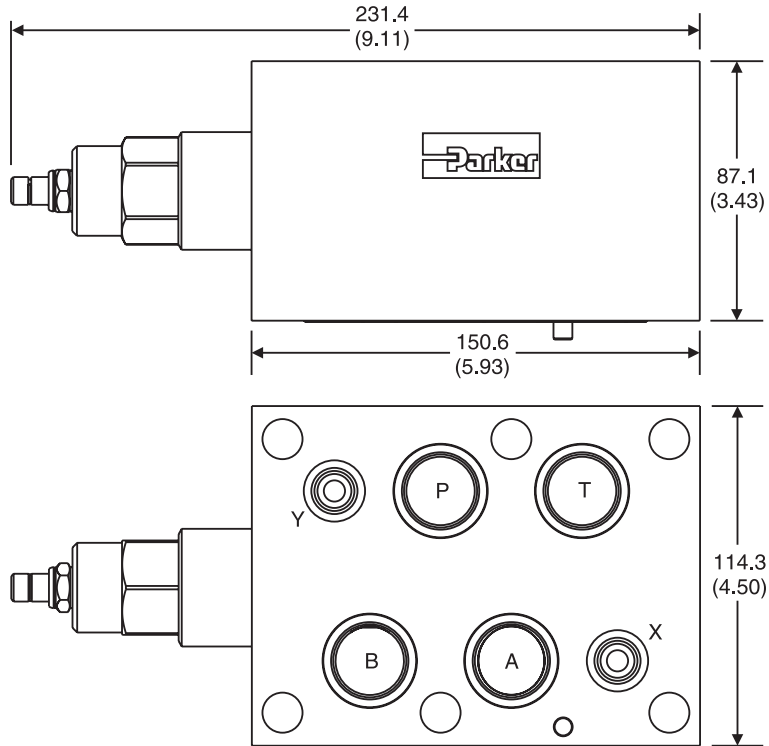

RV08DT — Inch equivalents for millimeter dimensions are shown in (**)

Note: This is a top view.

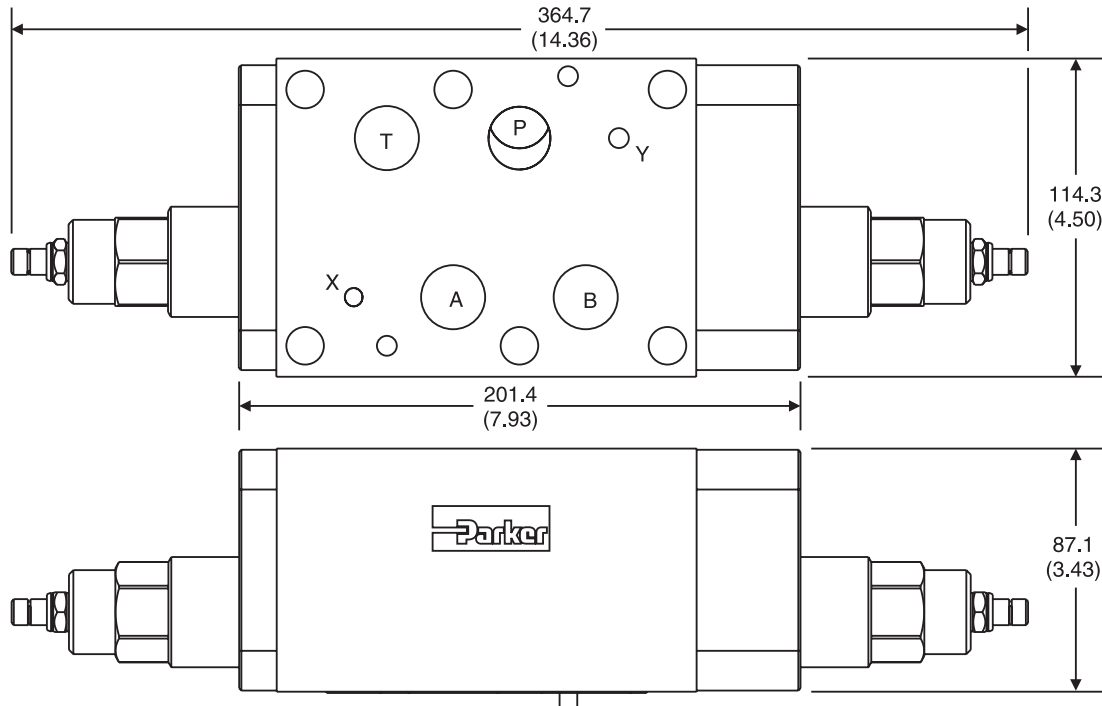

RV08DX – Inch equivalents for millimeter dimensions are shown in (**)

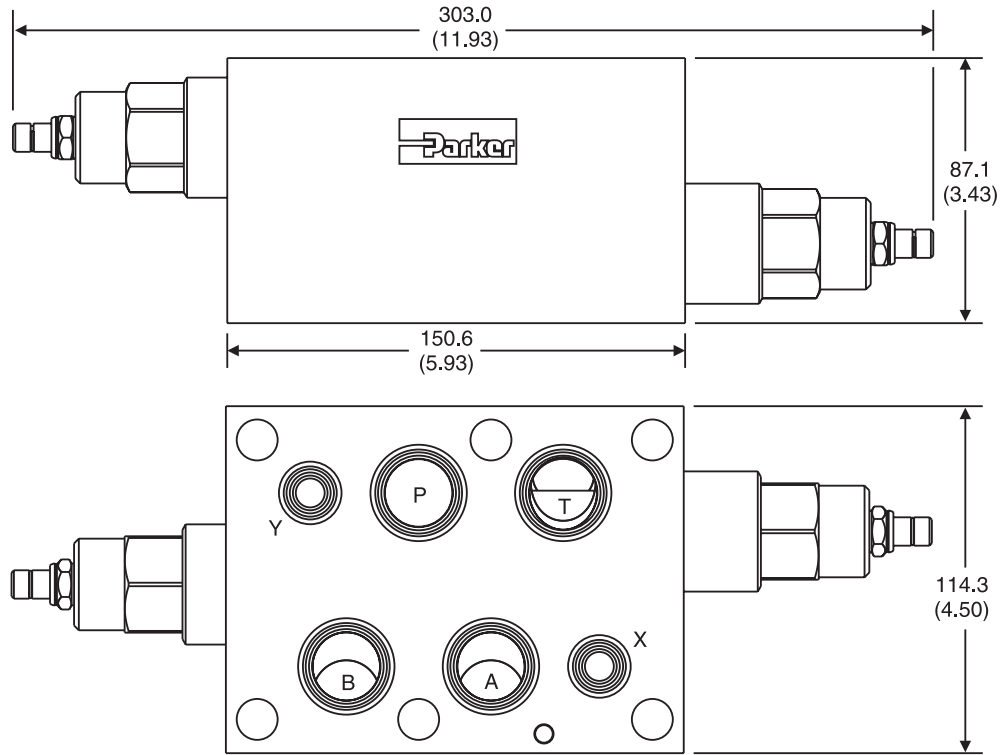

RV08PT – Inch equivalents for millimeter dimensions are shown in (**)

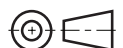
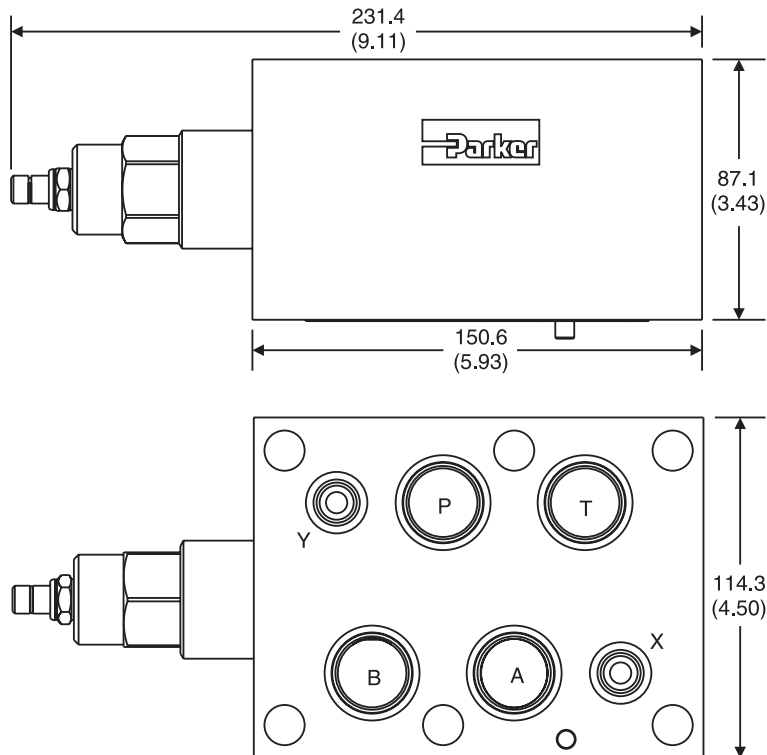



WARNING – USER RESPONSIBILITY

FAILURE OR IMPROPER SELECTION OR IMPROPER USE OF THE PRODUCTS DESCRIBED HEREIN OR RELATED ITEMS CAN CAUSE DEATH, PERSONAL INJURY AND PROPERTY DAMAGE.

- This document and other information from Parker-Hannifin Corporation, its subsidiaries and authorized distributors provide product or system options for further investigation by users having technical expertise.
- The user, through its own analysis and testing, is solely responsible for making the final selection of the system and components and assuring that all performance, endurance, maintenance, safety and warning requirements of the application are met. The user must analyze all aspects of the application, follow applicable industry standards, and follow the information concerning the product in the current product catalog and in any other materials provided from Parker or its subsidiaries or authorized distributors.
- To the extent that Parker or its subsidiaries or authorized distributors provide component or system options based upon data or specifications provided by the user, the user is responsible for determining that such data and specifications are suitable and sufficient for all applications and reasonably foreseeable uses of the components or systems.

OFFER OF SALE

The items described in this document are hereby offered for sale by Parker-Hannifin Corporation, its subsidiaries or its authorized distributors. This offer and its acceptance are governed by the provisions stated in the detailed "Offer of Sale" elsewhere in this document or available at www.parker.com/hydraulicvalve.

SAFETY GUIDE

For safety information, see Safety Guide SG HY14-1000 at www.parker.com/safety or call 1-800-CParker.



Parker Hannifin Corporation
Hydraulic Valve Division
520 Ternes Avenue
Elyria, Ohio 44035 USA
Tel: 440 366 5100
Fax: 440 366 5253
www.parker.com/hydraulicvalve

